

Industrial Batteries / Network Power

Sonnenschein A400 FT

dryfit<sup>®</sup> ✦  
✦ inside



»The *dryfit* range  
for *modular*  
performance adaption«

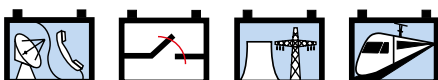

# Industrial Batteries

## The powerful range of Network Power

GNB® Industrial Power offers reliable energy storage solutions for critical systems requiring uninterrupted power supply. With a comprehensive product range based on state-of-the-art technologies, GNB delivers the right battery for every application.

The below table is only indicative and depends on the specific customer application. For more information please ask a GNB sales representative.

Applica-tions	Battery ranges																				
	Sonnenschein							Marathon		Sprinter		Absolyte	Powerfit	Classic							
	A400/A600	A400 FT	A500	A700	SOLAR	RAIL	Power Cycle	M-FT	L/XL	P/XP	XP-FT	GP/GX	S100/S300	GroE	OCSM	OPzS	Energy Bloc/OGi	Solar	rail		
Telecom 	●	●	●	●			●	●		●	●						●	●	●		
UPS 	●	●	●	●			●	●		●	●						●		●		
Emergency lighting 	●	●	●	●			●	●		●	●		●				●	●			
Security 	●		●	●						●	●		●			●	●				
Utility 	●	●		●			●	●				●		●	●	●	●				
Railways 	●	●	●	●		●	●	●				●					●		●		●
Photovoltaic 					●		●					●								●	
Universal 	●	●	●	●			●	●		●	●		●				●	●	●		

### Powerful product brands



> VRLA batteries (Valve Regulated Lead Acid) in which the electrolyte is fixed in an Absorbent Glass Mat (AGM)



- > Excellent high current capability
- > Very economical
- > Maintenance-free (no topping up)



- > VRLA batteries (Valve Regulated Lead Acid) in which the electrolyte is fixed in a gel (dryfit® technology)
- > Inventor of Gel technology
- > Highest reliability, even in non-optimal conditions
- > Particularly suitable for cyclic applications
- > Maintenance-free (no topping up)



- > Conventional lead-acid batteries with liquid electrolyte
- > Extreme reliability, proven over decades
- > Low maintenance

## Sonnenschein A400 FT

### The dryfit range for modular performance adaption

The Sonnenschein A400 FT is a premium battery, delivering superior cyclic performance and exceptional reliability due to the globally proven and successful dryfit technology. The location of the terminals on the front (vs. the top) of the battery greatly facilitates the installation and maintenance of the product when placed in a cabinet enclosure or on a standard relay rack tray.

#### Your benefits:

- > **dryfit Gel** – VRLA technology
- > **Lowest energy consumption** – saving costs
- > **Robust design** – resilient in harsh conditions
- > **Proof against deep discharge** – greater long-term energy delivery
- > **Low self-discharge** – high availability
- > **Front terminal design** – easy access for 23" cabinets
- > **Completely recyclable** – low CO<sub>2</sub> footprint



#### Specifications:

- > Design life »> 12 years – Very Long Life« according to EUROBAT 2015 classification
- > Superior cycle performance
- > Shelf life of up to 2 years without recharge (20 °C) due to very low self discharge
- > Very low gassing
- > Short recharge time
- > Grid plate made of lead calcium alloy
- > Trouble-free transport of operational blocks, no restrictions for rail, road, sea and air transportation (IATA, DGR, clause A67)
- > Approval: Underwriters Laboratories (UL)
- > Front access to the terminals M8 male
- > Insulated block connector and protected terminals
- > Handles for easy transportation
- > Polypropylene container
- > Designed in accordance with IEC 60896-21/-22
- > Proven life in many installations worldwide
- > Manufactured in Europe in our ISO 9001 certified production plants

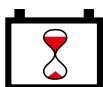

Design life  
> 12 years -  
Very Long  
Life



Nominal  
capacity  
120 Ah (C<sub>10</sub>)  
165 Ah (C<sub>10</sub>)



Block battery

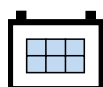

Grid plate



Recyclable



Valve regulated  
lead-acid  
batteries

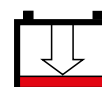

Proof  
against deep  
discharge



Maintenance  
free (no  
topping up)

## Sonnenschein A400 FT

### Technical data, Applications, Dimensions

#### Technical characteristics and data

Type	Part number	Nom. voltage V	Nominal capacity $C_{10}$ 1.80 Vpc 20°C Ah	Length (l) mm	Width (b/w) mm	Height (h) mm	Weight* approx. kg	Internal resistance mOhm	Short circuit current A	Terminal
A412/120 FT	NGA4120120HS0MA	12	120	548	115	275	40.0	7.00	1725	M-M8-45°

\* Actual weight may differ by ±5%

#### Applications

The dryfit Gel battery offers excellent performance in a variety of applications and is well suited to areas where the power supply is unstable and harsh outdoor environments are prevalent.

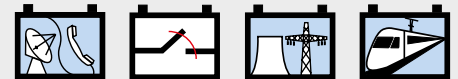

#### Drawings with terminal position, terminal and torque

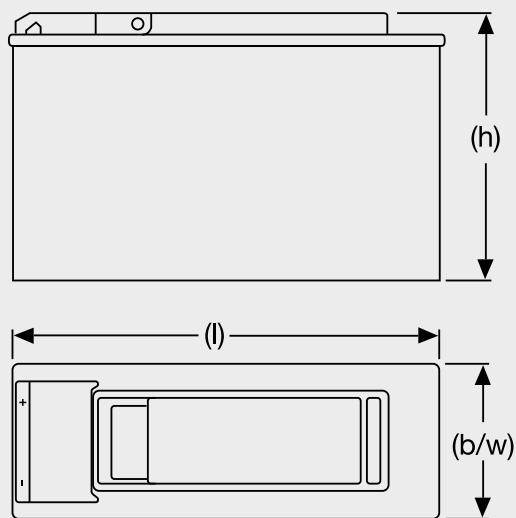

Not to scale!



8 Nm

## Sonnenschein A400 FT

### Constant current discharge

#### A412/120 FT – Discharge in A at 20 °C

Vpc	5 Min	10 min	15 min	20 min	30 min	45 min	1 h	2 h	3 h	4 h	5 h	8 h	10 h	20 h
1.90	141	123	117	104	84.6	66.4	56.1	36.0	26.6	20.9	17.6	12.4	10.7	5.75
1.87	162	137	128	113	90.6	71.1	60.0	38.4	27.7	21.8	18.3	13.0	11.2	5.99
1.85	190	152	139	121	96.0	75.3	63.5	39.6	28.6	22.5	18.9	13.4	11.5	6.17
1.83	204	162	145	127	100	78.8	66.1	40.4	29.1	22.9	19.3	13.6	11.8	6.30
1.80	216	172	152	132	104	81.4	67.5	41.0	29.6	23.3	19.6	13.8	12.0	6.40
1.77	227	180	157	137	107	82.8	68.1	41.5	29.9	23.5	19.8	14.0	12.1	6.46
1.75	238	189	163	141	109	83.8	68.8	41.9	30.2	23.8	20.0	14.1	12.2	6.53
1.73	249	198	168	144	110	84.6	69.5	42.3	30.5	24.0	20.2	14.3	12.3	6.59
1.70	261	206	171	145	112	85.5	70.2	42.7	30.8	24.3	20.4	14.4	12.4	6.66
1.67	273	211	173	147	113	86.3	70.9	43.2	31.1	24.5	20.6	14.6	12.6	6.73
1.65	278	213	174	148	114	87.2	71.7	43.6	31.4	24.8	20.8	14.7	12.7	6.79
1.60	290	218	178	151	116	88.8	72.8	44.3	32.0	25.2	21.1	15.0	12.9	6.91

#### A412/170 FT – Discharge in A at 20 °C

Vpc	5 Min	10 min	15 min	20 min	30 min	45 min	1 h	2 h	3 h	4 h	5 h	8 h	10 h	20 h
1.90	181	172	161	152	128	103	88.6	56.5	40.8	32.4	27.4	18.0	14.7	7.76
1.87	211	202	186	171	144	114	94.9	60.0	43.0	34.0	28.8	18.9	15.5	8.19
1.85	240	221	199	179	152	118	98.8	61.8	44.2	34.9	29.4	19.3	15.9	8.39
1.83	265	241	215	189	158	122	101	63.1	45.1	35.5	29.9	19.7	16.1	8.58
1.80	289	261	229	202	164	127	104	64.7	46.1	36.2	30.3	20.0	16.5	8.75
1.77	312	278	243	212	170	130	107	65.8	46.8	36.7	30.5	20.3	16.7	8.89
1.75	327	291	254	219	173	132	108	66.4	47.2	37.0	30.7	20.4	16.9	8.95
1.73	343	304	264	225	177	134	110	67.0	47.5	37.3	30.9	20.5	16.9	8.95
1.70	363	318	270	232	181	136	111	67.6	47.9	37.6	31.1	20.7	16.9	8.95
1.67	386	325	277	238	184	138	112	68.1	48.2	37.8	31.1	20.7	16.9	8.95
1.65	408	330	282	242	187	139	113	68.4	48.4	37.8	31.1	20.7	16.9	8.95
1.60	432	343	291	248	191	142	114	68.7	48.5	37.9	31.1	20.7	16.9	8.95

Initial capacity and power are according to IEC 60896-21/-22 minimum 95 % of published data.

## Sonnenschein A400 FT Constant power discharge

### A412/120 FT – Discharge in W/block at 20 °C

Vpc	5 min	10 min	15 min	20 min	30 min	45 min	1 h	2 h	3 h	4 h	5 h	8 h	10 h	20 h
1.90	1765	1459	1261	1110	927	774	681	462	329	259	215	153	127	71.3
1.87	1922	1660	1430	1248	1029	849	741	493	360	283	234	160	133	74.2
1.85	2054	1815	1568	1356	1105	901	780	513	379	296	245	164	136	75.7
1.83	2210	1918	1628	1428	1153	931	800	521	387	303	250	167	138	76.8
1.80	2354	2001	1683	1457	1185	957	821	532	396	310	256	171	141	77.8
1.77	2462	2088	1740	1499	1214	984	836	540	402	314	259	172	142	78.5
1.75	2568	2144	1790	1543	1241	998	847	549	405	316	261	173	143	78.8
1.73	2694	2193	1839	1585	1266	1011	856	554	408	318	262	174	144	79.1
1.70	2809	2245	1884	1620	1288	1025	866	558	410	320	263	175	144	79.3
1.67	2944	2284	1918	1651	1308	1036	874	559	412	321	265	176	145	79.6
1.65	3040	2309	1942	1668	1318	1042	880	561	413	322	265	176	145	79.7
1.60	3259	2409	1983	1681	1332	1050	888	566	416	323	266	177	146	80.0

### A412/170 FT – Discharge in W/block at 20 °C

Vpc	5 min	10 min	15 min	20 min	30 min	45 min	1 h	2 h	3 h	4 h	5 h	8 h	10 h	20 h
1.90	2172	2079	1961	1845	1523	1209	977	631	468	367	304	203	166	87
1.87	2553	2431	2256	2089	1642	1306	1048	668	494	387	320	213	174	92
1.85	2912	2736	2493	2220	1729	1352	1090	690	510	398	329	219	179	95
1.83	3207	2918	2640	2327	1800	1382	1125	708	522	408	337	224	183	98
1.80	3474	3139	2786	2456	1884	1416	1164	760	536	418	345	228	187	100
1.77	3688	3276	2880	2529	1930	1435	1184	766	542	423	348	230	189	102
1.75	3818	3348	2933	2571	1957	1450	1196	769	546	425	350	232	190	102
1.73	4019	3496	2974	2601	1976	1462	1205	772	549	427	352	232	190	102
1.70	4248	3622	3025	2641	2002	1478	1217	775	552	430	354	234	190	102
1.67	4419	3694	3054	2672	2022	1491	1228	778	555	432	354	234	190	102
1.65	4596	3795	3087	2689	2034	1498	1235	779	556	432	354	234	190	102
1.60	4796	3864	3128	2722	2057	1513	1250	783	557	433	354	234	190	102

Initial capacity and power are according to IEC 60896-21/-22 minimum 95 % of published data.

## Battery Service – Energy Solutions

Keeping your business on the move

### GNB® is the Expert

Who could do this job better than the professionals of a company with more than 100 years of experience in battery development, production and application?

Leave the responsibility for the maintenance of your batteries and chargers to the professionals: a GNB service contract provides you with exceptional economic advantages through time savings, cost savings and safety!



### Installation of Batteries and Systems for Network Power

- > Development of complete turnkey solutions from the design concept to installation and commissioning.
- > Installation according to legal and safety regulations including CE certification by approved installation technicians.
- > Training and certification of external installation technicians according to CE regulations.

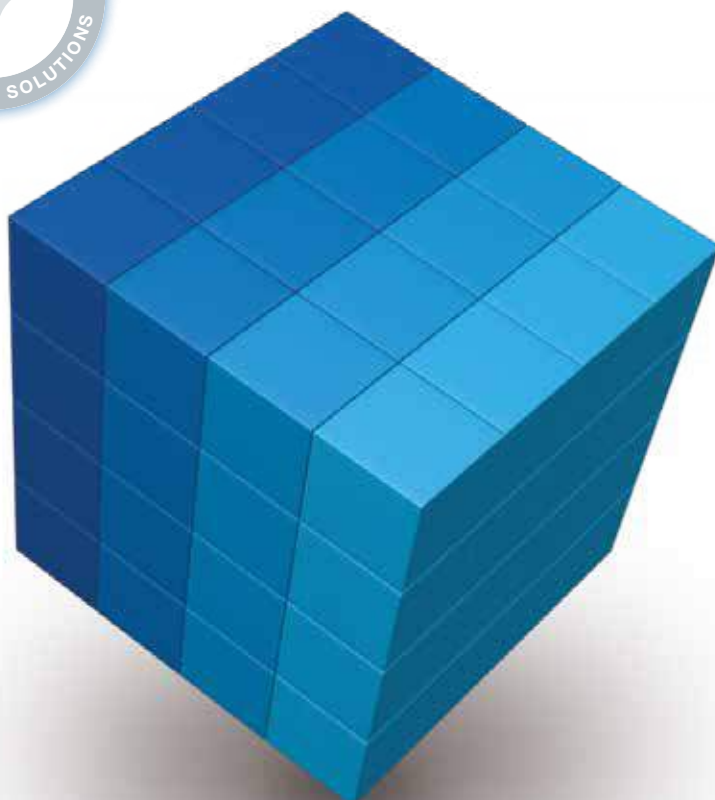

- ✦ Inspection Contract
- ✦ Maintenance Contract
- ✦ Lifetime Warranty Contract
- ✦ Full Service Contract

»GNB Service – individualized, professional and all over Europe!«



**Exide Technologies**, with operations in more than 80 countries, is one of the world's largest producers and recyclers of lead-acid batteries. Exide Technologies provides a comprehensive and customized range of stored electrical energy solutions. Based on over 120 years of experience in the development of innovative technologies, Exide Technologies is an esteemed partner of OEMs and serves the spare parts market for industrial and automotive applications.

**GNB Industrial Power** – A division of Exide Technologies – offers an extensive range of storage products and services, including solutions for telecommunication systems, railway applications, mining, photovoltaic (solar energy), uninterrupted power supply (UPS), electrical power generation and distribution, fork lifts and electric vehicles.

**Exide Technologies** takes pride in its commitment to a better environment. An integrated approach to manufacturing, distributing and recycling of lead-acid batteries has been developed to ensure a safe and responsible life cycle for all of its products.